

YOUR ADVENTURE UNFOLDS

Wisper

FeathercraftTM

FOLDING KAYAKS

Feathercraft Products Ltd. 4-1244 Cartwright Street on Granville Island, Vancouver, British Columbia, Canada V6H 3R8
Toll Free: 1-888-681-8437 Tel: (604) 681-8437 Fax: (604) 681-7282 www.feathercraft.com info@feathercraft.com

Contents

Wisper Folding Kayak	Page 2
Specifications	Page 3
Wisper Frame	Page 4
Care and Maintenance	Page 5
Wisper Assembly Instructions	Page 7
The Feathercraft Sea Sock.....	Page 19
Using Strap on Skeg	Page 20
Disassembly	Page 21

Wisper Folding Kayak

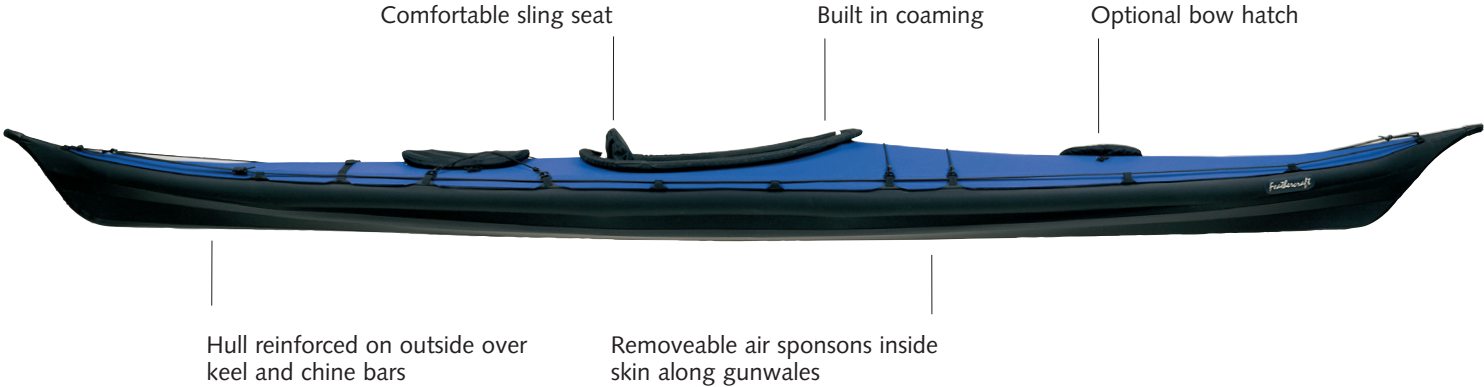

Strap-on skeg

Specifications

Length:	4.75 m (15'7")
Beam:	57 cm (23.5")
Weight:	
Standard Skin	17 kg (37.5 lbs)
Light Skin	15 kg (33 lbs)
Pack size:	95 x 47 x 25 cm (37.5 x 18.5 x 10")
Storage Volume:	Medium
Frame:	5/8" Round 6063 - T832 Extruded Aluminum Magnesium Tubing with clear Anodized Coating
Crossribs:	1/2" High Density Polyethylene
Skin Material:	Welded Urethane

Seat: 420 denier rip-stop nylon with inflatable air back and air bottom

Accessories: Included in every kayak:
Nylon Spray Skirt
Sea Sock
Adjustable Foot Brace
Medium Stern Hatch
Repair Kit
Pack Bag
Assembly Video
Illustrated Instructions
Strap-on Skeg

Options: Small Bow Hatch
Neo-nylon spray skirt
Calf plates

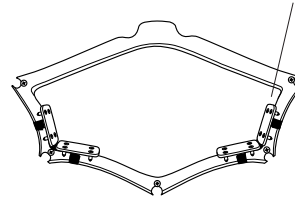

Wisper Frame

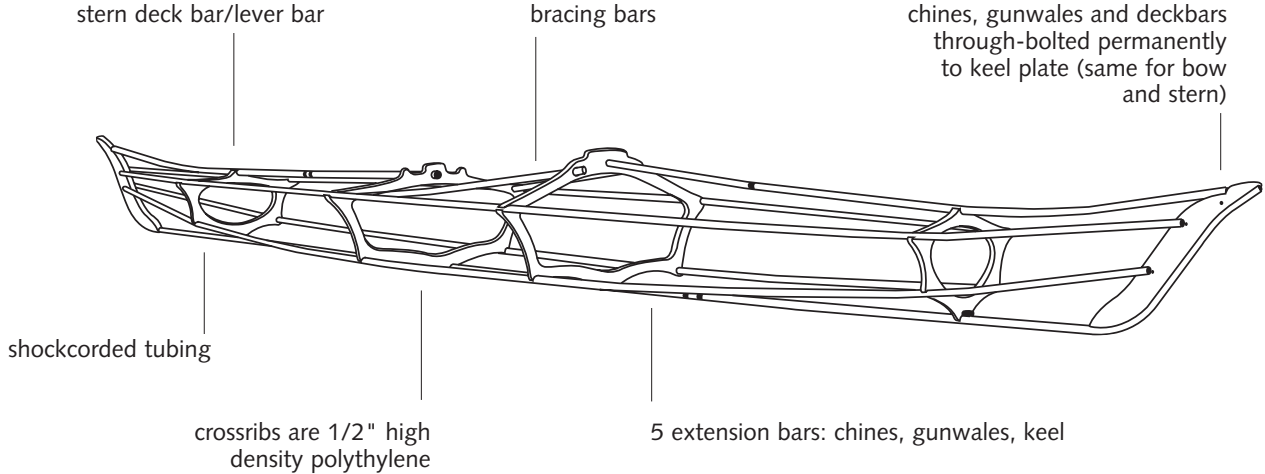

Care and Maintenance

The Frame

The tubular frame is very strong and corrosion resistant. We recommend that the frame be disassembled after extensive use (2 – 3 months). The inside and outside of the tubes should be washed with fresh water. Try to keep the inserts and extension bars free of sand and grit.

Included in your repair kit is a small dropper tube of Bo-Shield T-9. This product is made by Boeing and is an excellent lubricant and protectant for aluminum.

Aerosol containers of Bo-Shield can be found at marine hardware stores. We also have available 4 oz bottles of Bo-Shield. However, please note, that the lid closure is not suitable for shipping after the bottle has been opened. This container would be good for your “at home” clean-up. We also have available Super Lube. This is a teflon lubricant in gel form. This product is also available from bike shops.

Apply the Bo-Shield lubricant to frame tube inserts, spring buttons and sliding pieces prior to assembly. If you should leave your boat assembled for a maximum of two months, this will assist in preventing tubes seizing.

Other maintenance “musts”:

- every two months completely disassemble the kayak.
- wash the frame completely with fresh water.
- reapply lubricant and/or wipe down tubes with Bo-Shield T-9.
- after paddling, sponge out the inside of the kayak. Do not allow water to pool along keel bar.

The Skin

The surfaces of the skin will not rot. They are stable in sunlight and are very tear-resistant. On the hull, areas likely to be exposed to abrasion have been reinforced. However, we recommend care when approaching shore. Sharp rocks, and barnacles can penetrate the skin. Avoid pulling a loaded boat over rocks whenever possible.

For patching and repairs, a patch kit is included. For quick field repair, duct tape works very well, and is a good addition to your repair kit.

Welded Sealskin

The Polytech deck and Duratek hull are urethane. Seams are permanently sealed.

A patch kit is provided for deck, hull or sponson punctures. The urethane glue will work for repairs to all of these fabrics. For preparation and application, follow the instructions on the adhesive container.

Sponsons

Due to the tight fit of the skin, the sponsons are under considerable pressure and some seepage of air may occur. It is advisable to periodically reinflate the sponsons. After paddling on hot days, release air from sponsons.

To Repair/Replace Sponson

The sponsons can be completely removed from the sleeve sewn to the inside of the skin. Turn the skin inside out. The sponson chamber is open at bow and stern ends. Tie a long string through the hole in the tab at the end of sponson. Pull sponson through the center opening of the chamber (where sponson hose is attached). To reinstall, pull the cord attached to the new sponson back through the chamber. Ensure sponson is not twisted in the chamber. Repeat with the opposite side. Urethane glue and patches are included in the repair kit. Duct tape works well on the sponsons.

Wisper Frame Parts

Bracing bars



Stern deck bar / vertical lever bar



Bow deck bar / horizontal lever bar



Rim inserts



Stern deck bar with double band of tape



Stern section

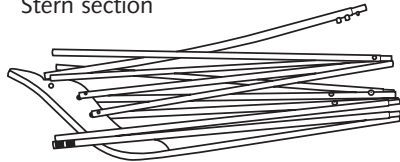

#1



#2

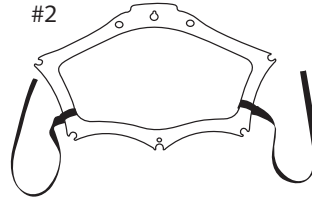

#3

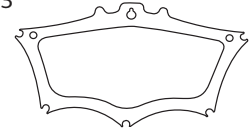

#4

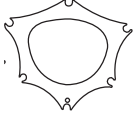

Keel extension bar



Seat Sling with chine and gunwale extension bars*

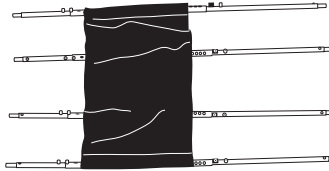

Bow section

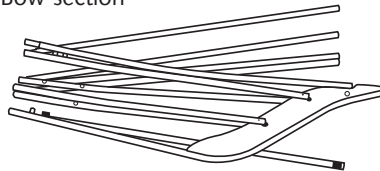

Bow deck bar with single band of tape



Foot brace platform

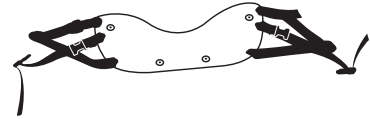

Seat

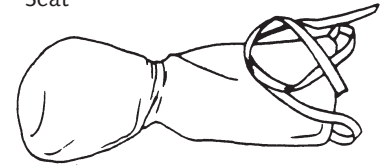

Skin



*Chine and Gunwale bars are a two-piece extension bar, and have been taken apart to fit into the pack bag.

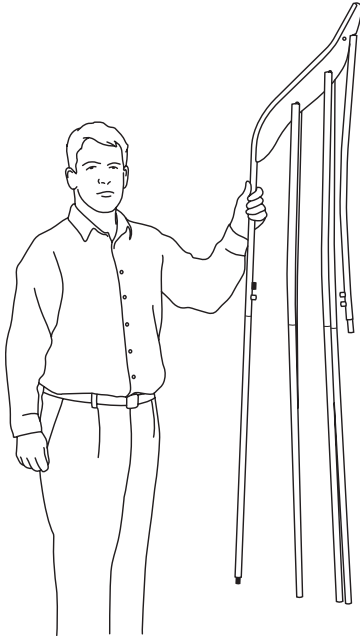

1 SET OUT FRAME PARTS AS ILLUSTRATED ON THE PREVIOUS PAGE

2 BOW SECTION

- "Shake" out bow section. Shock corded tubes take shape.
- Attach bow deck bar with single band of black tape.

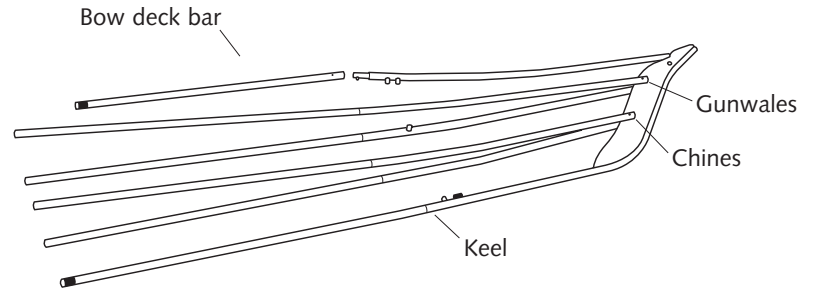

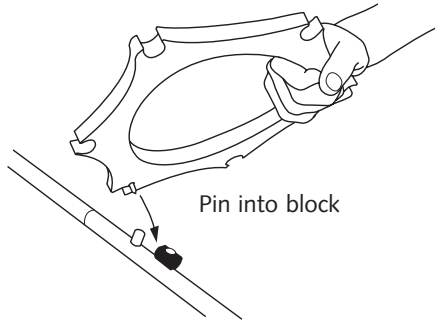

3 ATTACH SMALL CROSSRIB #1 TO BOW SECTION

- Pin on small crossrib is inserted into hole in plastic block on keel tube.
- Chine and gunwale tubes snap-fit onto crossrib with white spacers on "cockpit" side of crossrib.

4 COMPLETE BOW SECTION

5 STERN SECTION

- Shake out stern section as you did the bow.
- Attach stern deck bar with double band of black tape.

6 ATTACH SMALL STERN CROSSRIB #4 AS YOU DID WITH THE BOW

Bow section complete

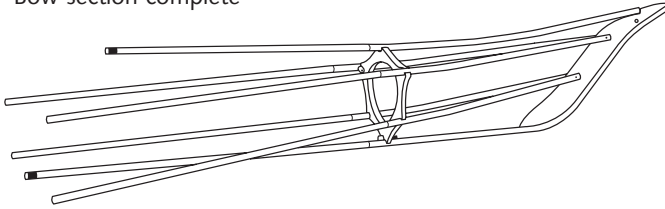

Attach stern deck bar

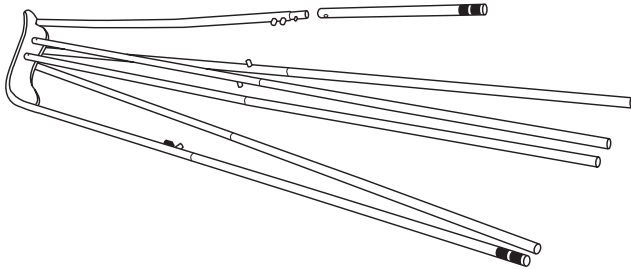

Snap chines, gunwales and deck bar onto crossrib.

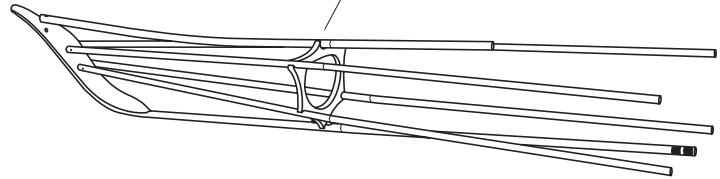

Insert bow frame section

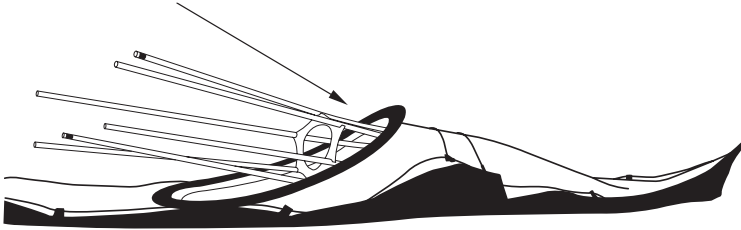

7 UNFOLD SKIN. INSERT BOW AND STERN FRAME SECTIONS

- Feathercraft logo is located at the bow. There are three velcro tab closures along the inside keel of the skin. Open the velcro tabs. Slide the bow and stern sections into the skin.

Center the frame along the inside keel strip, pushing sections to the very ends. From the outside of the skin, check the frame alignment along the keel strip. Secure velcro closures around the keel tubes.

8 INSTALL KEEL EXTENSION BAR

- Keel extension bar has two bands of black tape on the stern end, and one band of black tape on the bow end.
- Attach the stern end of the extension bar on to the stern keel bar. Slide the bar apart, attaching the other end to the bow keel bar.



Stern

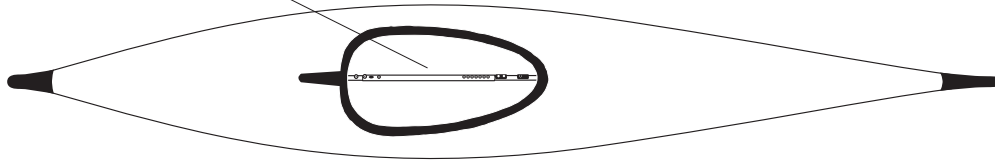

Bow

9 **INSTALL CHINE AND GUNWALE BARS WITH SEAT SLING.**

The seat sling will be suspended from the chine and gunwale extension bars. These extension bars are all the same. Have the extension bars inserted to the sewn sleeves of the seat sling. Place the seat sling with the extension bars into the kayak with the Safety label towards the bow. Large lever hole in extension bars is at the stern. Single black block goes towards bow.

(Note: When installing the extension bars, it is easier to be situated on the opposite side from the part you are installing.)

The bow and stern frame tubes will have begun to curve to the shape of the skin. To allow the extension bars to connect easily onto the tubes in the skin, bring the tubes into a straight line to join together.

With the seat sling positioned in the cockpit, slide the chine extension bars apart, connecting to bow and stern chine bars. Do the same for the gunwale extension bars. Complete opposite side.

Slide the seat sling towards the stern so you have easy access to the spring buttons and lever hole.

10 EXPAND EXTENSION BARS

- Once all extension bars are in place, using stern deck bar/vertical lever and bow deck bar/horizontal lever, expand the keel extension bar until you feel tension. Spring button appears in hole.

Expand chine and gunwale extension bars with lever bars. Position is approximately in the center hole and the skin should feel tight.

Note: When assembled at the factory, the final position of the spring button on the extension bars is the second hole from the bow. On the thigh braces, it is the middle hole. The spring button position can, and probably will, vary slightly depending on the weight of the skin, as well as over time. This is normal and acceptable.

(Remember to situate yourself across from the parts you are installing.)

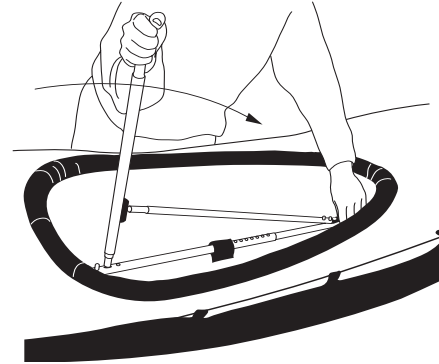

11 INSTALLING LARGE CROSSRIBS

- Angle the crossrib towards the spacers on the keel, chine, and gunwale tubes. Position the crossrib between the spacers, pushing the rib onto the tube.

For the bow crossrib, there is a pin at the base of the rib. Two black blocks are mounted on the keel bar. The “twister” is mounted with one screw, and should be in the open position. Insert the pin on the base of the crossrib into stationary black block (with two rivets). Close the “twister”.

Stern crossrib

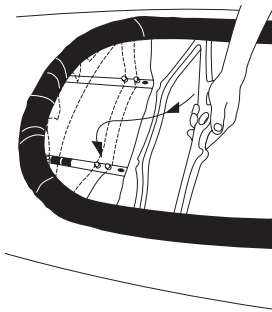

Bow crossrib

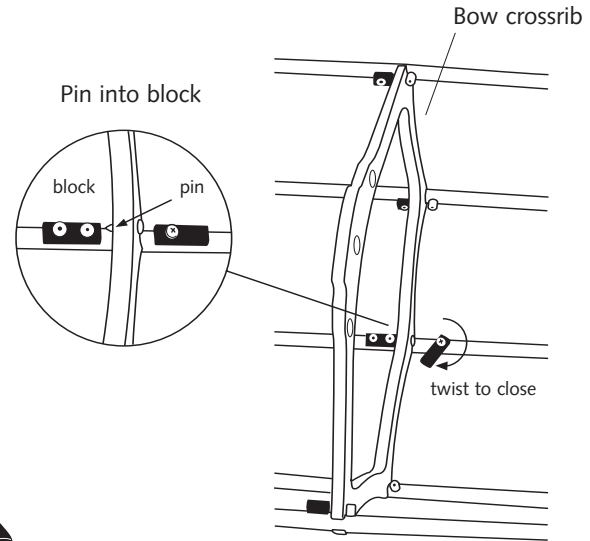
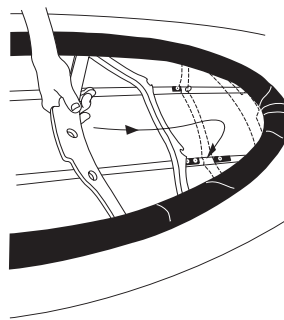

12 SECURE UNDER DECK BUCKLE WITH WEBBING AROUND STERN CROSSRIB

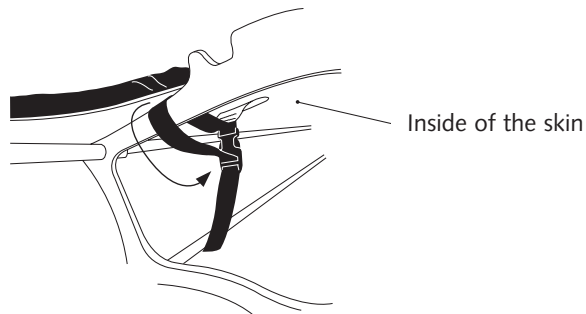
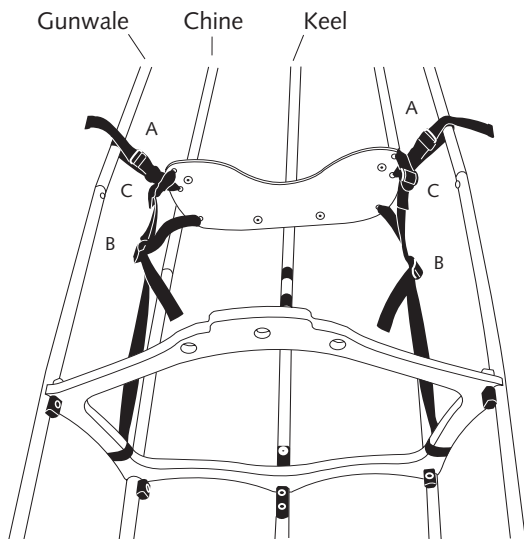

13 INSTALL FOOT BRACE / PLATFORM

A: Side-squeeze buckles on the foot brace connect around gunwale bars of bow frame section.

B: Webbing from #2 crossrib attaches to tension lock. Adjust distance for leg length with this buckle.

C: This tension lock adjusts the angle of the bracing platform.

To load the bow of the kayak, unclip one side of the platform at buckle A for easy access.

14 INSTALL BOW DECK BAR

- Connects to bow deck bar on bow frame section.

Insert deck bar through keyhole

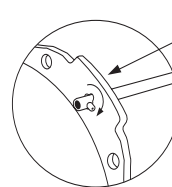
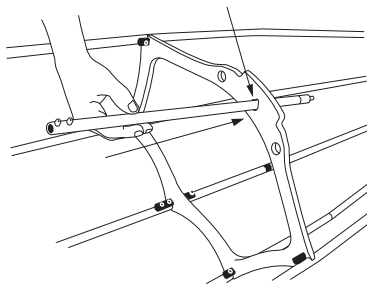

Rotate deck bar to lock

15 INSTALL STERN DECK BAR

- Connects to stern deck bar on stern frame section.

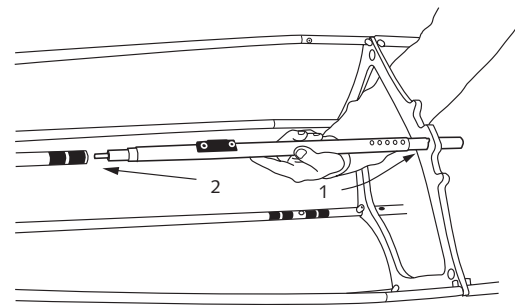

Once connected, rotate deck bar to lock in crossrib

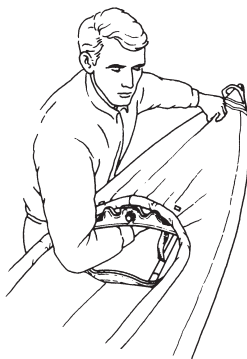
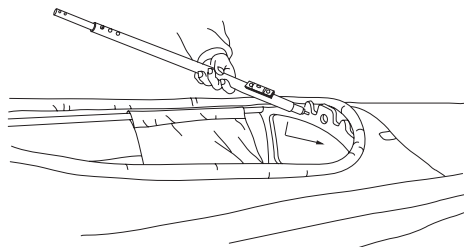

16 INSTALL RIM INSERTS

- Slide into pocket on underside of coaming rim.

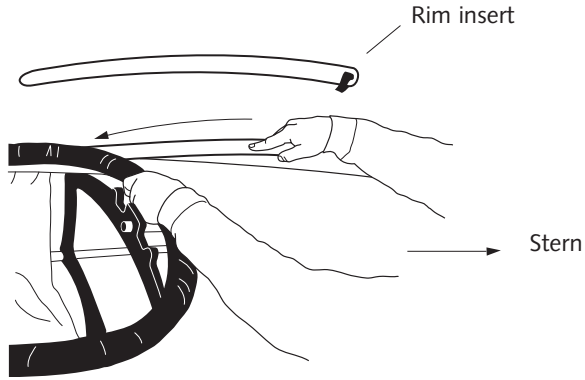

17 INSTALL THIGH BRACES

- Slide oversleeve on thigh brace towards bow. Insert stern end of tube (a) through hole in large stern crossrib. Insert bow end (b) through hole in large bow crossrib. Slide oversleeve towards stern till snug and spring button appears.

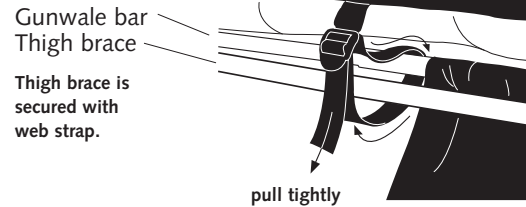
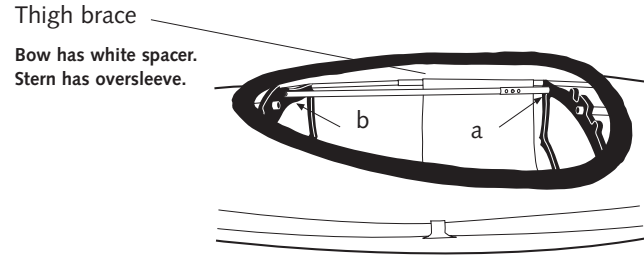

18 INFLATE SPONSONS

- Turn the top of the valve to open. When inflating sponsons, alternate sides to ensure the frame remains centered. The air pressure from the sponsons can shift the frame within the skin. Keep blowing until the skin is tight. Twist cap to close. Tuck sponson tubes and valves out of the cockpit area. Avoid stepping on the hose and valve, and try to keep the valve free of sand.

Note: After paddling on hot days, release air from sponsons.

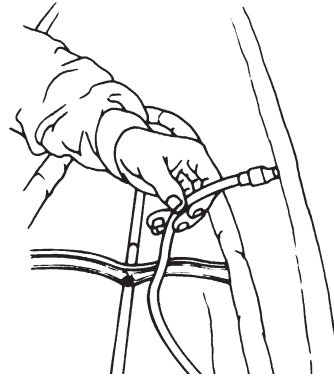

19 INSTALL SEAT

- Inflate air bladders in the seat back and bottom to suit personal comfort. (Less air in bottom is usually better.)

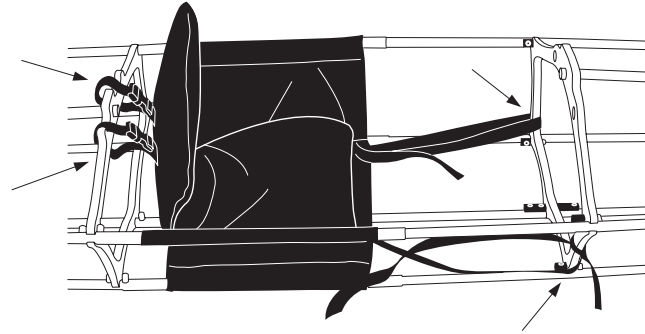

20 COMPLETE HATCHES

- Attach hatch rim by folding the fabric sleeve sewn to the deck over the rim. Roll down inner closure and close with buckle. Place hatch cover over rim and secure with B-lock.
- During disassembly, don't forget to take the plastic rims off. Don't roll the skin up with the rims still in place.

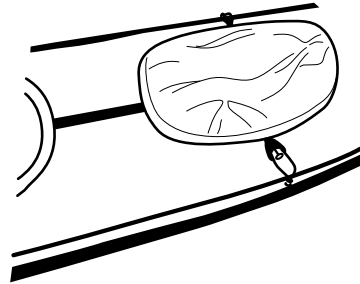
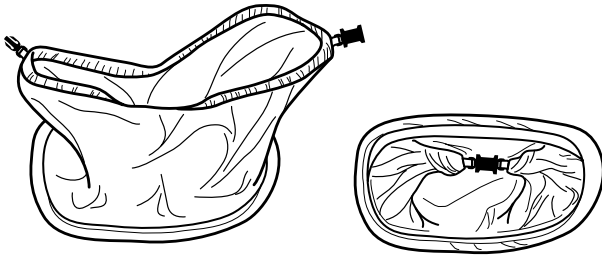

21 THE FEATHERCRAFT SEA SOCK

- Made from high-quality coated nylon, the sea sock is a great safety item. The top of the sock fits tightly around the cockpit coaming rim. Contoured to fit along the seat-back and bottom, the “foot” is loose through the cockpit, creating a “pod”. The paddler then sits in the sock. Legs and feet are not constricted. The spray skirt fits as usual. In the event of a capsize, water will only enter the sock, and not the whole boat. It’s also great for keeping the inside of your kayak clean.

Tips on Usage and Installation

- The shiny side of the fabric faces in towards the kayak frame.
- When facing the bow of the kayak, the Feathercraft label should be on the right side.
- Center the seam on the rim of the sea sock with the center point on the bow of the coaming.
- Once the Sea Sock is in place, sit in the sock, and “burp” it by lifting the edges, releasing trapped air that causes the sock to billow up.

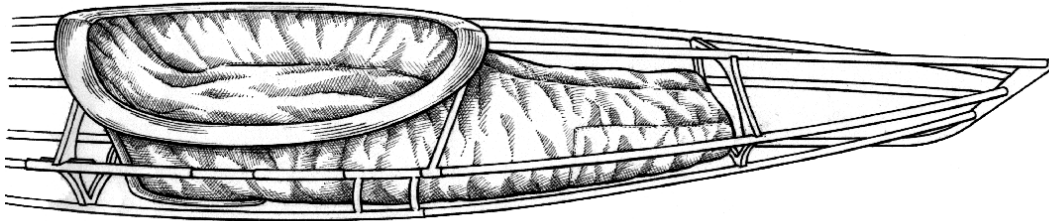

22 TIPS ON WHEN TO USE THE SKEG

- The Wisper is designed to work well without a rudder. However, in some conditions you may find it easier to paddle with the skeg installed. This is most likely to occur when the boat is loaded and you are heading downwind. Under these conditions the kayak may have a tendency to “weathervane” or turn upwind. The skeg minimizes this tendency.

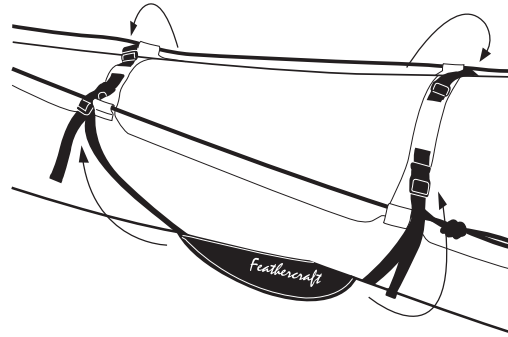

Disassembly

Let the air out of the sponsons. Remove rim inserts. Remove deck bars. Remove bracing bars and large crossribs. Remove Gunwale and Chine Extension bars using the lever bars to release the spring buttons. Release the Keel Extension Bar last. Follow the rest of the assembly steps in reverse order.

Packing the kayak in the bag

Put the seat cushion in the bag first. Arrange the white plastic crossribs over the seat. Roll the kayak skin up tightly—fold the ends to the center of the kayak; fold in half; roll tightly; secure with webbing ties. Place the skin bundle in the middle of the bag; put the bow and stern frame bundles on either side of the skin. Take chine and gunwale extension bars apart, leaving one half installed in the seat sling. Roll up the loose sections together in the seat sling. Tuck all additional pieces (ie: sea sock, repair kit) into any available space.

Lifting the Kayak

The kayak can be lifted with two people, one at either end; at either side of the cockpit, holding the frame cockpit area; or one person, lifting over the shoulders.

Avoid lifting a fully loaded kayak.

Storage

Once clean and dry, the kayak can be stored assembled or disassembled in a shaded, dry place. When storing the kayak disassembled, take extension bars apart.

© Feathercraft Products Limited 2005
Printed in Canada, revised 5/2006
Recycled paper

